

REGO-FIX®



No thru coolant?
Now affordable
retrofitting
with reCool®!

Made in
Switzerland



www.reCool.ch

reCool®
Coolant Supply

reCool® Rotary Coolant Supply System

- Converts existing tooling systems to thru coolant at low costs in 2 minutes
- For using ER-collets in driven tools with metric external thread (ISO 15488/DIN 6944)
- Speeds up to 6,000 rpm*
- Coolant pressures up to 20 bar / 290 PSI*
- Maintenance free coolant lubricated bearings
- For coolant through tools (with DS sealing discs) and for peripheral cooling (with KS flush discs)

*Higher speeds and coolant pressures available upon request.



Peripheral Cooling without reCool®

- Limited adjustment of the nozzles or spray tubes with different tool length and diameters
- Lower tool life since coolant is not led directly to the cutting edge
- Scattering losses of the spray jet
- Bad chip removal

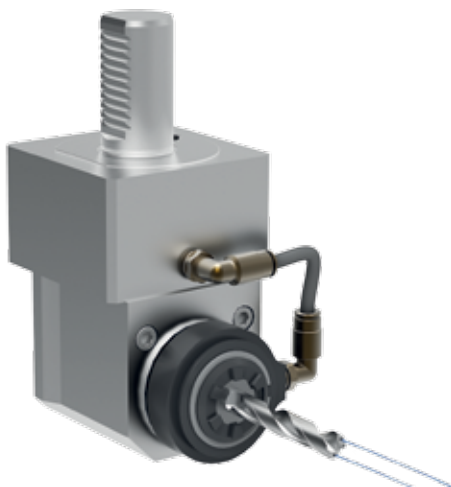

Internal Cooling with reCool®

- + Optimum coolant supply (for all tools, also for difficult to access machining)
- + No scattering or spray losses
- + Optimized coolant quantity for each tool
- + Best chip removal



Swiss
Precision
Tools

reCool® Rotary Coolant Supply System – Set RCR/ER

Type	Part No.
RCR/ER 16	3716.00000
RCR/ER 20	3720.00000
RCR/ER 25	3725.00000
RCR/ER 32	3732.00000
RCR/ER 40	3740.00000

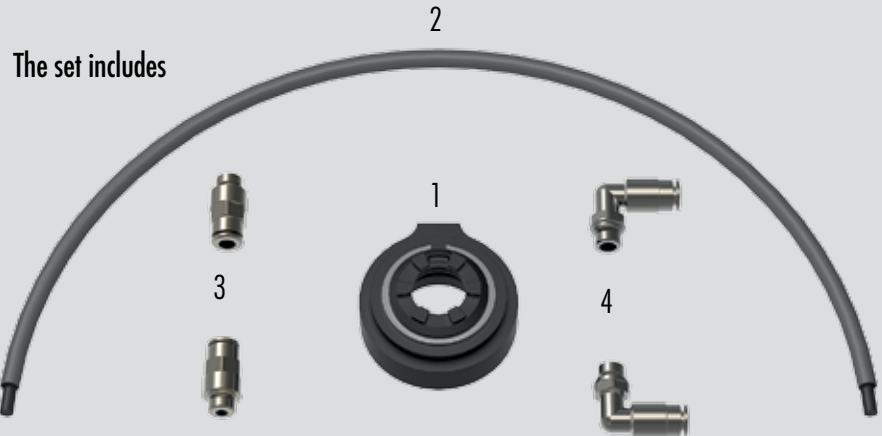

Pos.	Pce	Type	Description
1	1	RCR/ER	reCool® clamping nut with outer ring
2	1	SET RHS	Coolant pipe with protector Ø 6 mm, 400 mm length
3	2	SET RVG 1/8" – 0°	1/8" BSP straight push-in fitting
4	2	SET RVA 1/8" – 90°	1/8" BSP 90° elbow push-in fitting

reCool® Optional Accessories

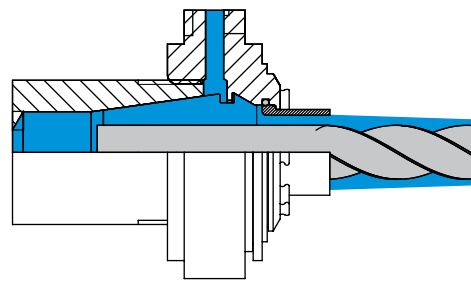
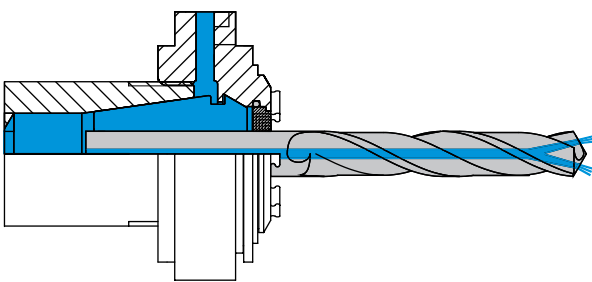

REGO-FIX® Sealing Discs DS/ER

	Type	Sealing capacity [mm]
	DS/ER 16	2.50 - 10.00
	DS/ER 20	2.50 - 13.00
	DS/ER 25	2.50 - 16.00
	DS/ER 32	2.50 - 20.00
	DS/ER 40	2.50 - 26.00

REGO-FIX® Coolant Flush Discs KS/ER

	Type	Clamp. capacity [mm]
	KS/ER 16	3.00 - 10.00
	KS/ER 20	3.00 - 13.00
	KS/ER 25	3.00 - 16.00
	KS/ER 32	3.00 - 20.00

reCool® Optional Accessories

Fittings Straight

	Type	Part No.
	SET RVG M8 x 1 – 0°	3799.92810
	SET RVG 1/8" – 0°	3799.92180

Fitting 90° Elbow

	Type	Part No.
	SET RVG 1/8" – 90°	3799.92189

Ball Adapters 1/8" BSP

	Type	Part No.
	RBA 10 / Ø 10.0 mm	3799.93100
	RBA 11 / Ø 11.0 mm	3799.93110
	RBA 12 / Ø 12.0 mm	3799.93120
	RBA 13 / Ø 13.0 mm	3799.93130
	RBA 14 / Ø 14.0 mm	3799.93140
	RBA 15 / Ø 15.0 mm	3799.93150
RBA 16 / Ø 16.0 mm	3799.93160	

Aluminium Ring Adapters 1/8" BSP

	Type	Part No.
	RRA 10 / Ø 10.0 mm	3799.94100
	RRA 11 / Ø 11.0 mm	3799.94110
	RRA 12 / Ø 12.0 mm	3799.94120
	RRA 13 / Ø 13.0 mm	3799.94130
	RRA 14 / Ø 14.0 mm	3799.94140
	RRA 15 / Ø 15.0 mm	3799.94150
RRA 16 / Ø 16.0 mm	3799.94160	

Torque Wrenches TORCO-FIX

	Type	Part No.	Range [Nm]
	TORCO-FIX 0	7150.02025	2 - 25
	TORCO-FIX I	7150.05050	5 - 50
	TORCO-FIX II	7150.20200	20 - 200
TORCO-FIX III	7150.60300	60 - 300	

REGO-FIX® Collets ER Standard

	Type	Clamp. capacity [mm]
	ER 16	0.50 - 10.00
	ER 20	0.50 - 13.00
	ER 25	0.50 - 17.00
	ER 32	1.00 - 22.00
ER 40	2.00 - 30.00	

REGO-FIX® Collets ER Ultra-Precision

	Type	Clamp. capacity [mm]
	ER 16	0.50 - 10.00
	ER 20	0.50 - 13.00
	ER 25	0.50 - 17.00
	ER 32	1.00 - 22.00
ER 40	2.00 - 30.00	

Coolant Pipe with Protector

	Type	Part No.
	SET RHS	3799.91000

Spanner

	Type	Part No.
	E 16 AX	7117.16000
	E 20 AX	7117.20000
	E 25 AX	7117.25000
	E 32 AX	7117.32000
E 40 AX	7117.40000	

Wrench Heads

	Type	Part No.
	A-E 16 AX	7157.16000
	A-E 20 AX	7157.20000
	A-E 25 AX	7157.25000
	A-E 32 AX	7157.32000
A-E 40 AX	7157.40000	