



HARTNER

Precision Cutting Tools

TM vending machines

New: Additional Configuration
Possibilities

2010





Intelligent tool management – around the clock

Now you can concentrate on your own core activities. Hartner does not only supply high-tech cutting tools but also offers intelligent systems to store, manage and distribute tools:

- Hartner TM Multi vending machine
- Hartner TM vending machine

Franz Dollenmayer, machining technology, Emmingen

Franz Dollenmayer, machining technology is a specialist for standard and special milling cutters who supplies the surgical industry, mechanical engineering companies as well as the engine and aircraft industry in Southern Germany and Austria. For the management and storage of tools at the customer Franz Dollenmayer, machining technology, relies on the Multi-Vend Tool Management System from Hartner.

„Wow! We thought as soon as we began assembling the Multi-Vend Tool Management System from Hartner: The infinite options for the configuration of the vending machine from the drawer sizes to their partitioning as well as the special paint finish of the machine and the stock control possibilities have convinced us.

Following a pleasingly short delivery time, which as well as the installation was as always perfectly organised. The software was easy to understand and the training of personnel could be carried out in double quick time.

Our customers use Hartner's Multi-Vend Tool Management System to manage Dollenmayer tools as well as their equipment and measuring instruments. The simple and intuitive handling ensures all tool movements are booked and all withdrawals are allocated to an order, a cost centre or an employee. Incorrect bookings can be corrected instantly and the employee responsible is always fully informed of the stock levels.

The automatic stock control notifies us directly of the requirement once or twice a week and in most cases the machine is restocked on the same day. Machine down time due to unavailability of tools is a thing of the past.

Our customers are thrilled with the Multi-Vend Tool Management System and we are happy to have satisfied customers.“

Franz Dollenmayer

www.dollenmayer.de





HARTNER

The TM Software

Both Hartner TM vending machine systems use the TM Software, offering the following advantages:

- simple, intuitive user guidance.
- comprehensive stock management functions.
- three-step cost hierarchy for clear cost allocation of tool withdrawals.
- exact consumption analyses to different criteria, as for example, tool consumption per component, machine or production area, ABC analyses.
- display of pictures and CAD graphics.
- measuring equipment management.
- re-grind management.
- production of tool stocklists.
- connection to SAP, TDM, Coscom, IBM, ODBC, WebRFC, Zoller Measuring Systems etc. possible via appropriate interfaces.
- individual solutions can be programmed on customer request.
- the software is available in the languages German, English, French, Italian, Dutch, Polish, Danish, Hungarian, Czech, Spanish, Portuguese and Chinese (traditional).

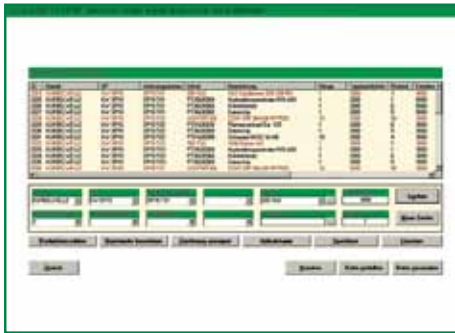

Bill of materials management for the production of new and for maintaining existing tool stocklists.



Dispensed tools can be allocated to different cost groups.

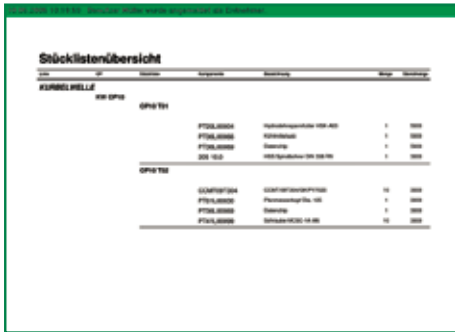

Stocklist print-out, display of required data according to customer specifications.



Tool selection according to different criteria, i. e. article no., description or size.

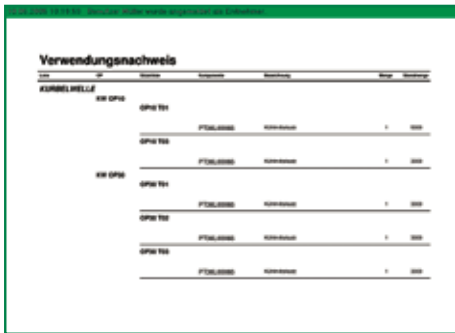

Usage verification regarding the application of tools.



ABC-analysis for a detailed cost distribution.



Hartner TM Multi vending machine

The TM Multi vending machine offers the following facilities:

- electronically locking tool dispensing system made of robust sheet steel
- draws fully extractable (max. load per draw 180 kg)
- dividers for individual draw compartments
- Hartner TM software
- operation via touch-screen monitor and Barcode scanner
- online connection to one or several suppliers via the Internet
- interfaces to external WWS/ERP-systems
- PC with MS Windows XP operating system
- system expandable via additional modules

The TM Multi vending machine offers the following specific advantages:

- transparency regarding tool consumption, cost allocation and stock control
- 24 hour, controlled tool availability
- prevention of production stoppages through monitoring minimum stock levels
- reduction in stocking and administration costs
- personnel awareness regarding tool cost (i.e. by displaying tool cost)
- open system (can include several suppliers)
- data can be applied in other ERP/PPS systems

Spiral insert for single dispense



Tool withdrawal from the separate drawer

Partition/compartiment examples



Lockable compartments



Non-slip mat



Channel sets





Options and dimensions

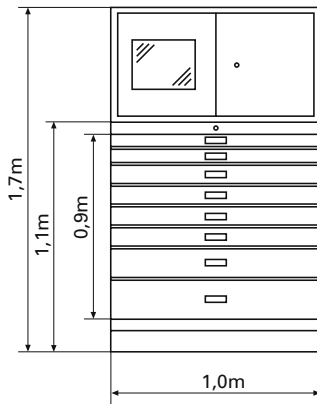

Base unit Multi vending machine
Width: 1,0 m
Height: 1,1 m + 0,6 m (control unit)

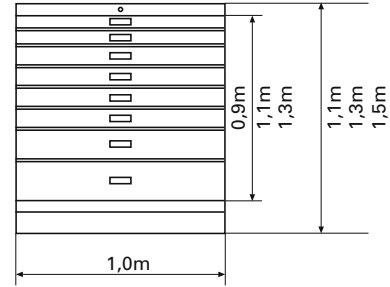
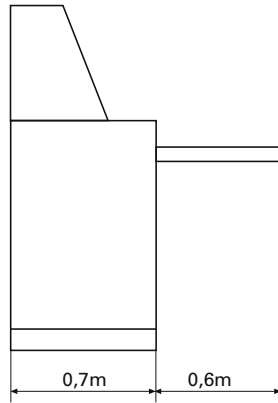

Additional unit Multi vending machine
Width: 1,0 m
Height: 1,1 m / 1,3 m / 1,5 m

Standard drawers

Heights: 75 mm / 100 mm / 125 mm / 150 mm
200 mm / 250 mm / 300 mm

Partitioning material:

- anti-slip mat
- recess sets
- compartment inserts
- partitions
- various tool holder systems

Drawers with spiral insert

- drawer height: 150 mm
- spiral insert for a maximum of 10 spirals

additional requirement:

- withdrawal drawer with withdrawal shaft and 3 manually lockable compartments, drawer height: 150 mm

Other

- forklift base with removable front panel
- operating voltage: 230 V / 50 Hz

Drawers with electronically locked storage compartments

Available drawer heights:

- 75 mm (effective height 50 mm)
- 100 mm (effective height 75 mm)
- 150 mm (effective height 125 mm)

Compartments per drawer	Internal dimensions width depth	Compartment layout	
		width	depth
48	109 mm x 75 mm	8	x 6
40	109 mm x 95 mm	8	x 5
32	109 mm x 125 mm	8	x 4
36	146 mm x 75 mm	6	x 6
24	146 mm x 125 mm	6	x 4
18	146 mm x 175 mm	6	x 3
24	220 mm x 75 mm	4	x 6
20	220 mm x 95 mm	4	x 5
16	220 mm x 125 mm	4	x 4
12	440 mm x 75 mm	2	x 6
8	440 mm x 125 mm	2	x 4

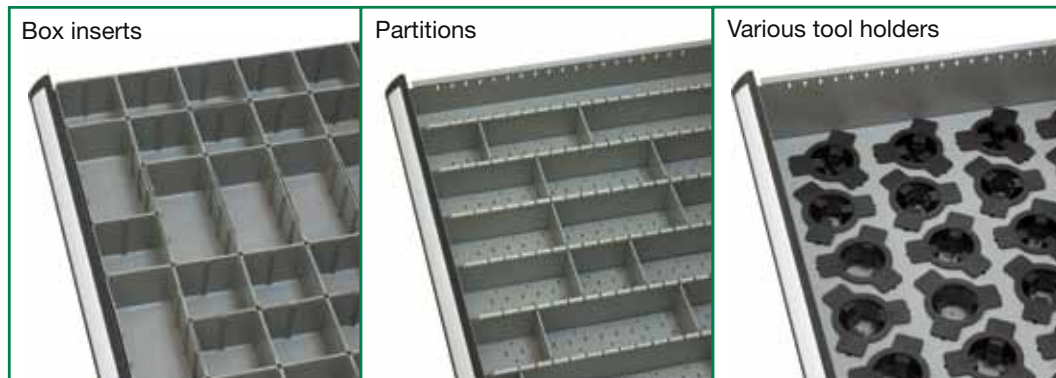



Hartner TM vending machine - Modular design

The TM vending machine is adaptable to your specific tool and storage requirements. The modular construction from different units enables the design of the TM Vending System to exactly meet the customer's needs.

The basis of the TM vending machine is centred around the control unit, which contains the control electronics, the operating program with touch-screen and barcode reader as well as manually lockable drawer for keyboard and additional stock.

To extend the control unit there is a choice of further modules, that can be freely combined with the control unit and are naturally also designed according to your requirements.

When configuring the drawer module, the height as well as the compartment set-up of each drawer can be individually chosen, always providing optimal storage space as well as an ideal storage system for the smallest to the largest tool.

Spiral modules are especially suited for storing and dispensing tools in compact dimensions and required in large quantities. Restocking is either via a cabinet door providing access to the entire spiral system or via drawers enabling access to the individual sections of the spiral system (multi-supplier capability).

A vertical pullout module is available for extra length tools or tool holders. The folding door module can be supplied with either two or eight compartments.

Thanks to its adaptability to the customer's individual stock requirements, the TM vending machine not only provides the possibility of secure tool storage and management, but other production equipments (so-called C articles) are also catered for.



Control unit: Operating element with PC, touchscreen and scanner; manually lockable compartments.

Expansion module fully automatic drawer: Model with automatically lockable drawers in different heights and with individual partitioning.

Expansion module spiral machine: Model with cabinet door, designed with 60, 70 or 80 spirals.

Expansion module spiral machine: Multi-supplier capability with drawers for restricted access when stocking.

Expansion module vertical pullout: Secure storage place for extra length tools, i.e. gun drills up to a length of 1500 mm

Expansion module folding doors: Secure storage place for large tools.





HARTNER

Options and dimensions

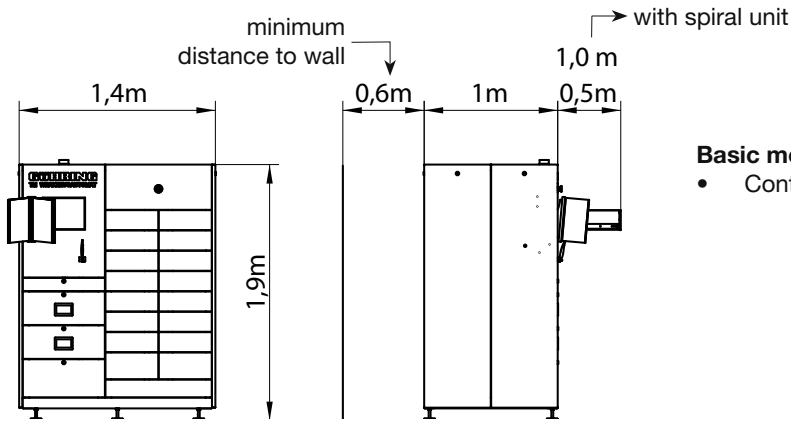

Basic module

- Control unit + module to customer requirements

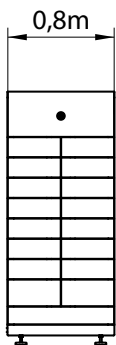

Drawer module

- Useable width: 210 mm
- Useable depth: 460 mm
- Useable heights: 40 mm / 65 mm / 90 mm / 140 mm / 190 mm

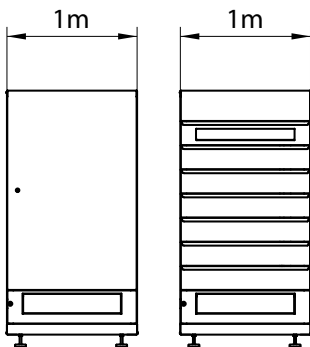

Spiral module

- Type S with cabinet door and up to 60 / 70 / 80 spirals
- Type M with 7 individual pullouts, multi-supplier capable, maximum 70 spirals
- Type E for single withdrawal with one withdrawal flap per pullout, avoids fall of tools, maximum 70 spirals

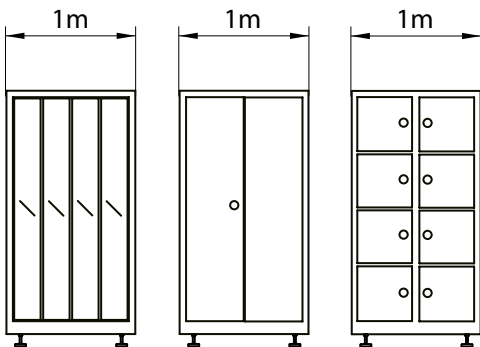

Vertical pullout module

- 4 vertical pullouts, maximum loading capacity 200 kg per pullout
- model with accessibility on both sides
- model with 5 compartment floors and 4 holder carriers each (HSK, SK, Capto)

Folding door module

- model with 2 electronically lockable folding doors and 4 compartment floors

Lockable compartment module

- model with 8 electronically lockable compartments

Other

Operating voltage: 230 V / 50 Hz

Network connectivity: RJ 45 interface



Our Program:



FU 500/FN500



Gun-Drills



INOX-Drills



Standard solid carbide de-burring tools



Micro-Precision-Drills



Multiplex



TS-Drills



Standard range



Highlights



TM vending machines



Special Drills

Hartner GmbH

P.O. box 10 04 27, D-72425 Albstadt

Tel. +49 74 31/1 25-0, Fax +49 74 31/1 25-5 47

www.hartner.de